

CS 321: Introduction to HCI

Methods for Design, Prototyping and Evaluating User Interaction

Lecture 06:

Design Process &
Design Diamond

Eren Gultepe
SIUE

The logo for Southern Illinois University Edwardsville (SIUE), featuring the letters "SIUE" in white on a red rectangular background.

What we will do today

Design Process and Design Diamond

Sketching

Creativity

Getting the Right Design

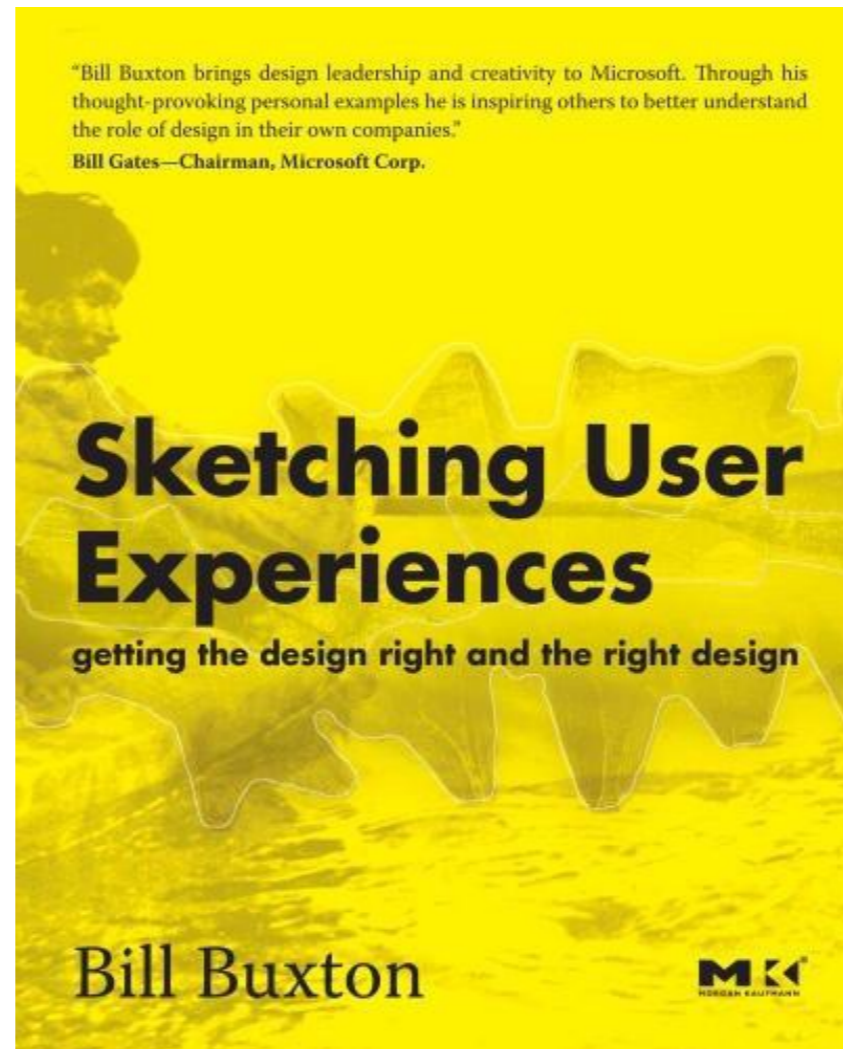

Design Process in a Nutshell

Framing the problem

- User research
- Competitive analysis
- Data analysis and summary

Exploring the solution space

- Brainstorming
- Ideation through sketching

Finding a good solution

- Scoping
- Consideration of constraints
- Scenarios, storyboards, personas
- Design rationale

Refining the solution

- wireframes
- lo-fi prototypes
- early evaluations
- mockups/mid-fi prototypes
- additional evaluations

Design Process in a Nutshell

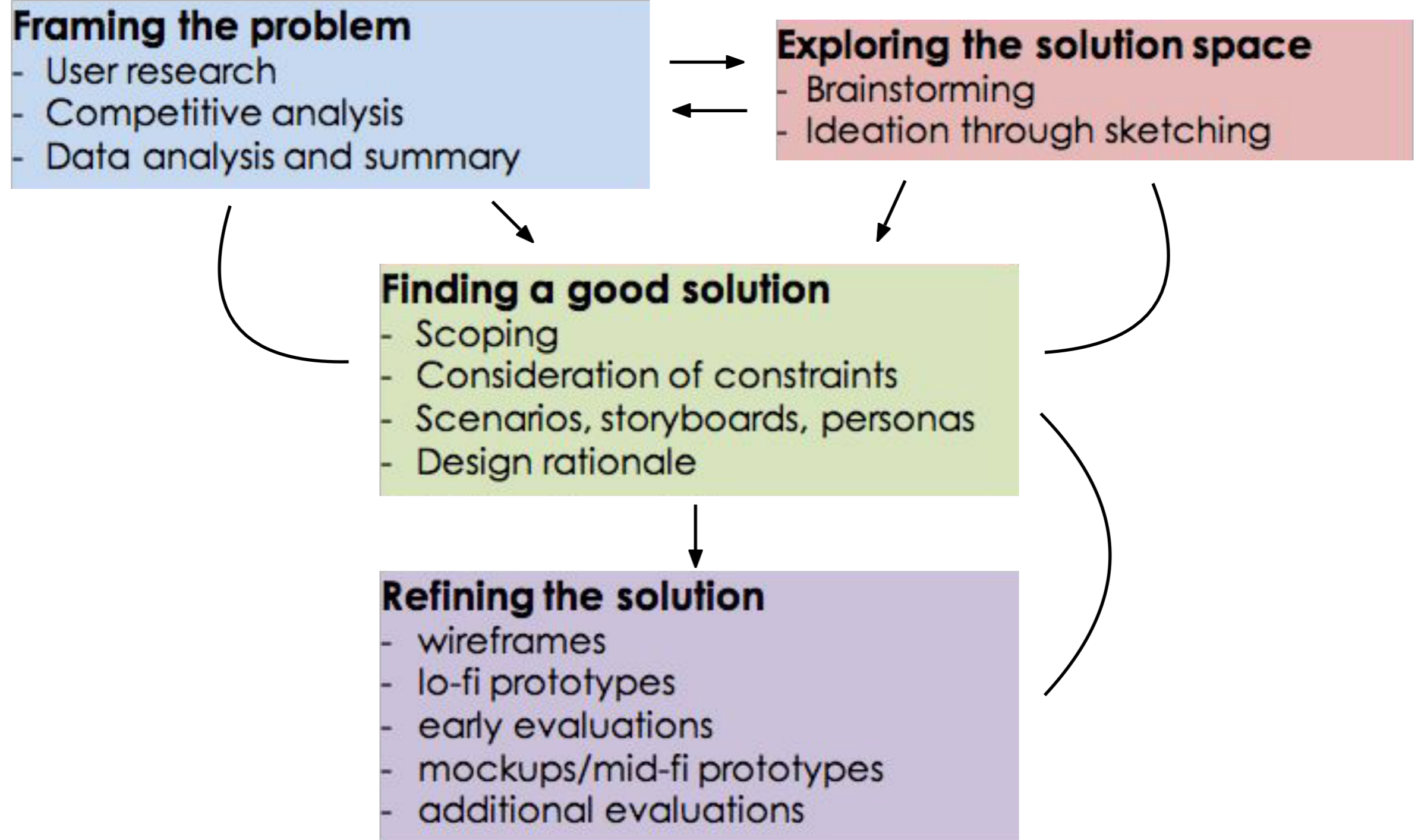

Design as a Choice

Elaboration

palette of choices

Reduction

heuristics to choose

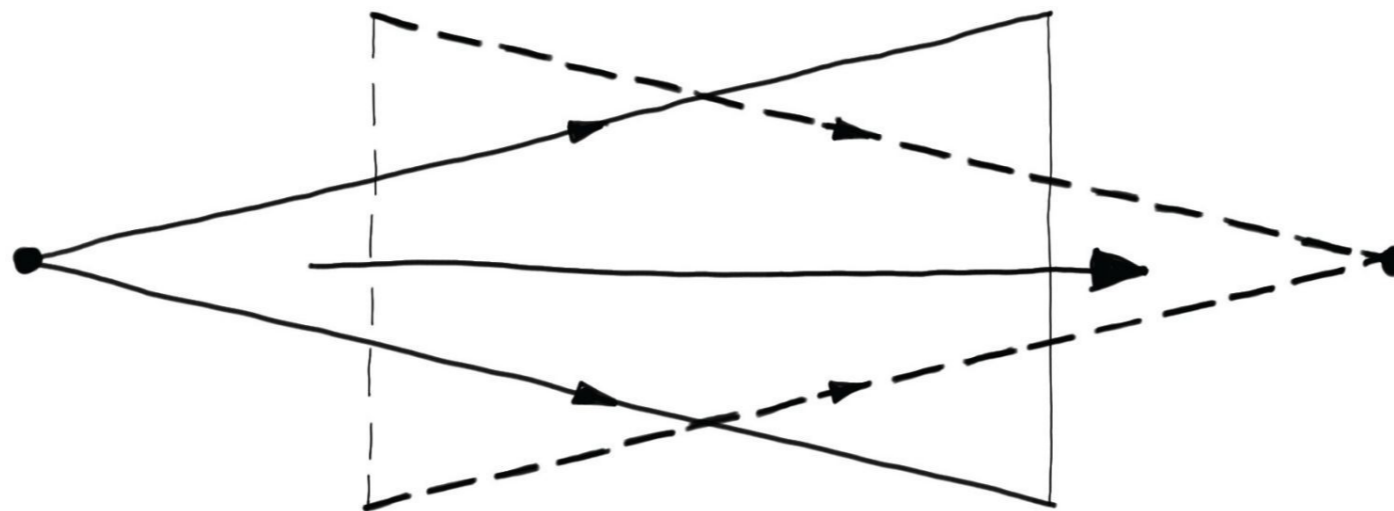

Design as Choice

Two openings for creativity

Palette of choices

Heuristics used to choose

Why is your design research so important?

What you learn directly informs both of these, shaping everything you do this entire semester

The Design Diamond

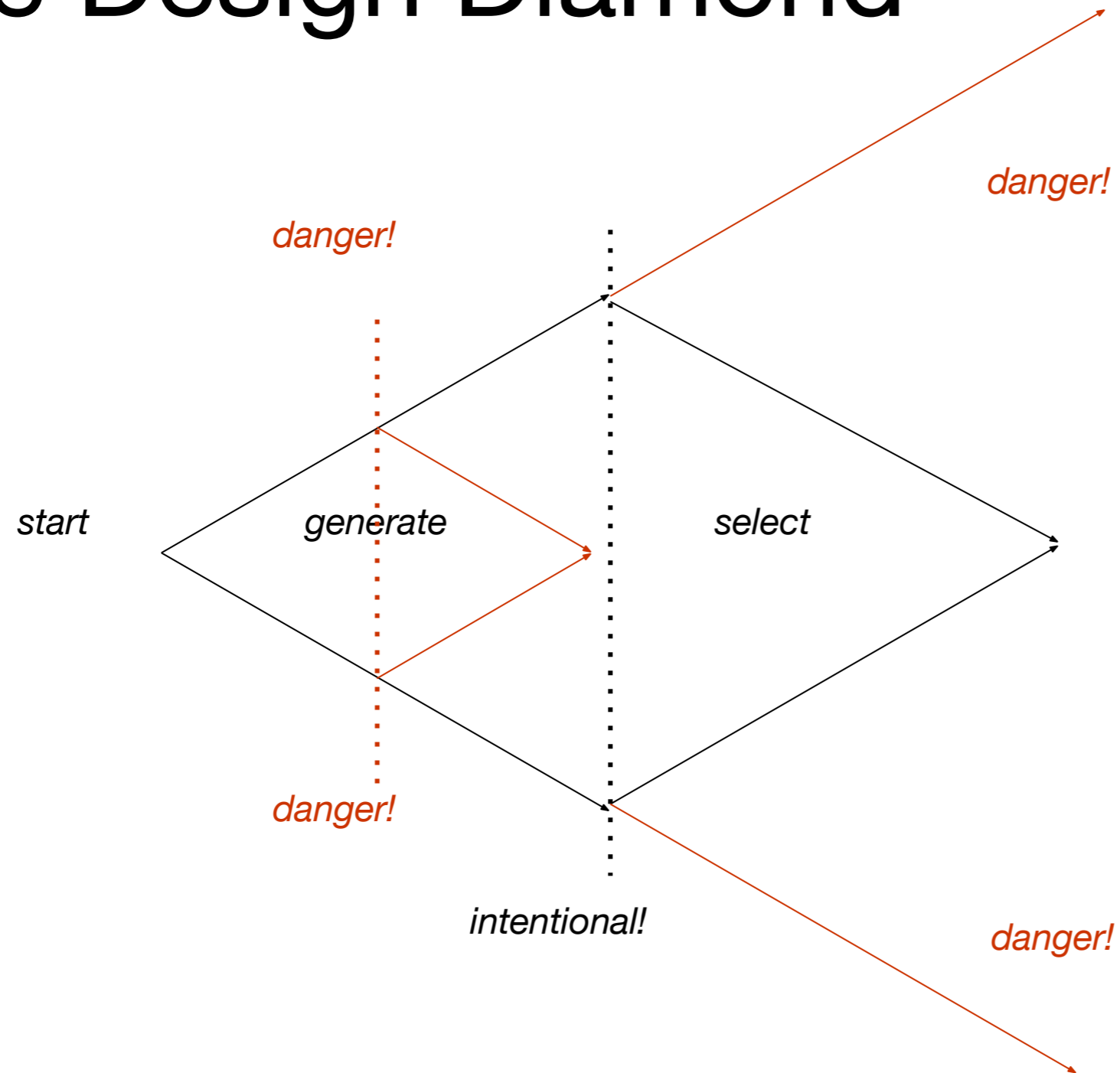

Critiquing design ideas

Ideas are both good and bad

Both are useful in design

By making clear what is a bad design,

we can avoid actually implementing it

Bad ideas help you justify your good ideas

Feedback can turn a good idea into a great idea

Idea Oscillation

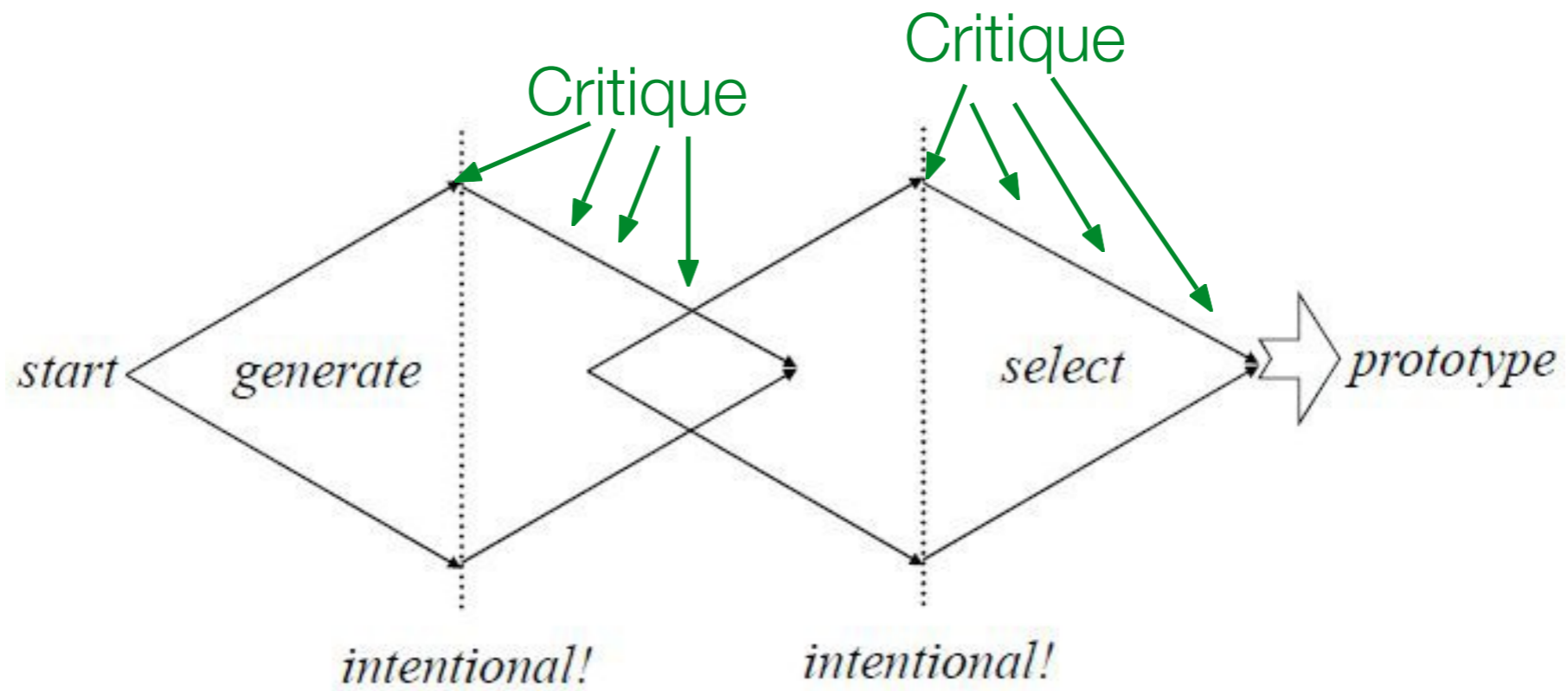

Cost of Iteration Toward a Design

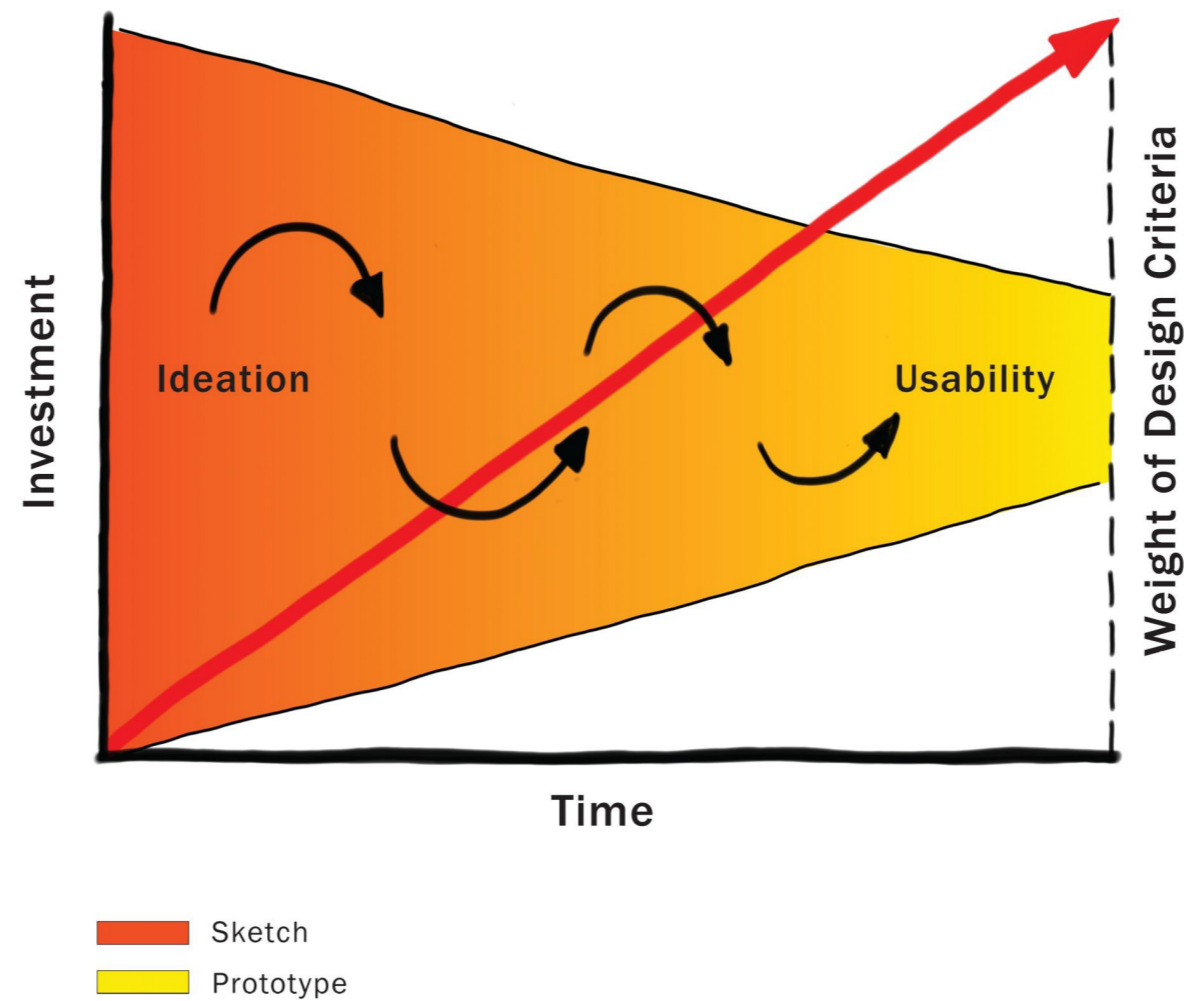

Exploration of Alternatives

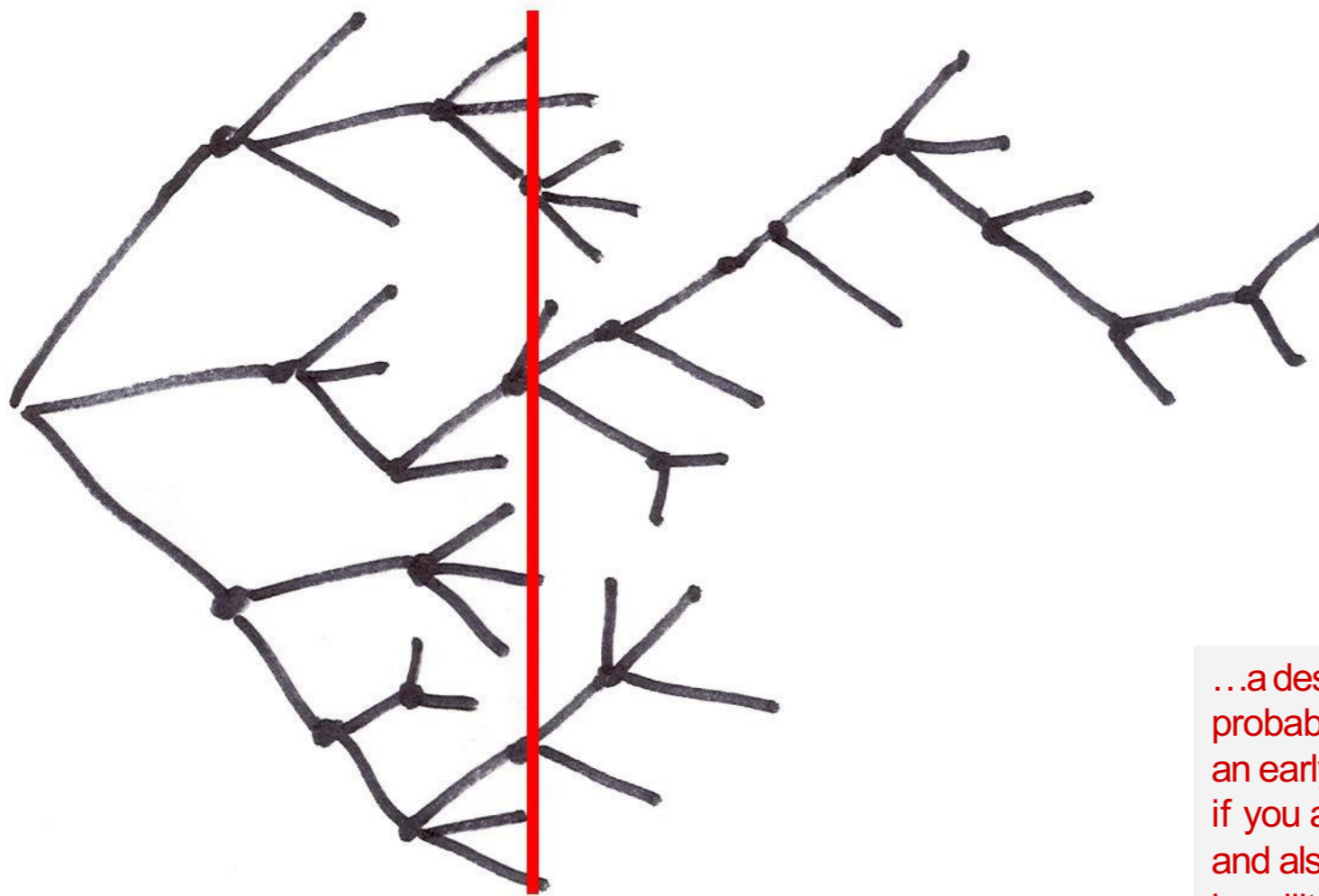

...a designer that pitched 3 ideas would probably be fired. I'd say 5 is an entry point for an early formal review (distilled from 100's). ... if you are pushing one you will be found out, and also fired. ... it is about open mindedness, humility, discovery, and learning. If you aren't authentically dedicated to that approach you are just doing it wrong!

Alistair Hamilton
VP Design
Symbol Technologies

The Converging Path

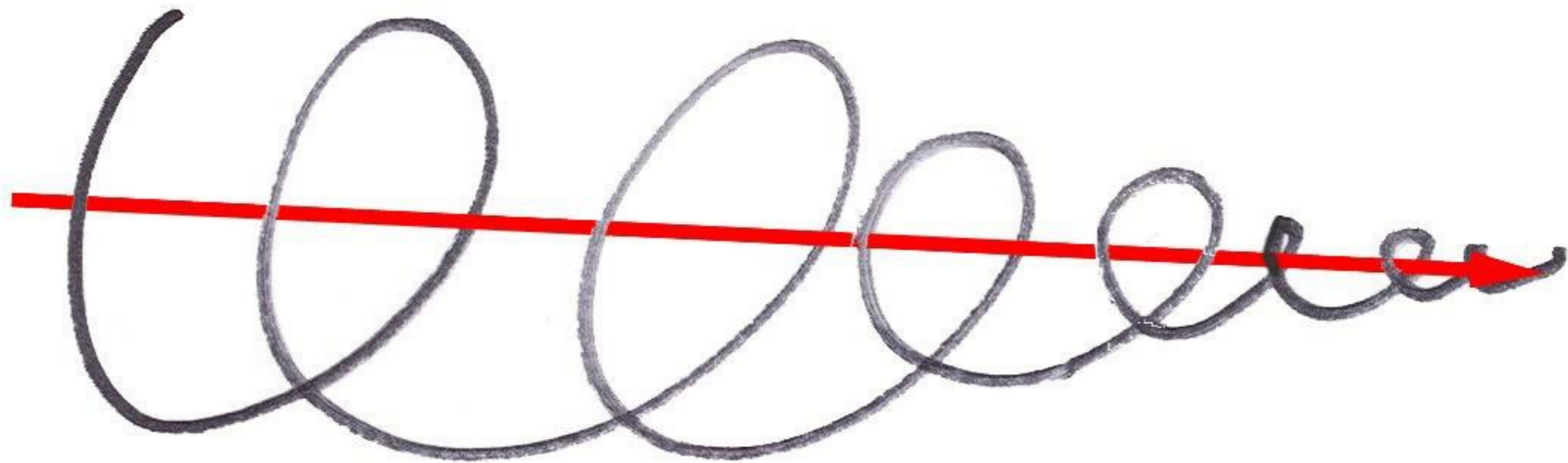

Let ideas oscillate...



The fourth generation of the iPod was successful

Sketching as a way to boost
creativity

Sketching

Movies

Theater: Shattuck Cinemas
Phone: (510) 665-1342 Dist: 1.5 mi
Address: 2122 Shattuck Ave
Berkeley, 94709
Cost: \$8.50 normal, \$6.00 senior, \$4.50 matinee

Map-It+

<u>Art of War</u>	☆☆☆
(10:00)-(1:00)-4:00-7:00-10:00	
<u>Bittersweet Motel</u>	☆☆☆☆
(11:00)-(1:30)-4:00-6:30-9:00	
<u>Godzilla</u>	☆☆
(10:30)-(2:00)-5:30-9:00	
<u>The Cell</u>	☆☆☆☆
(11:00)-(1:00)-3:00-5:00-7:00-9:00	

STORE FOR THE STYLE-CHALLENGED

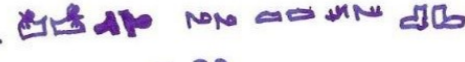

As is...  ...

...  ...

...  ...

 ? ? ? ?

As it should be...

outfit #1  outfit #2  outfit #3 

(pre-selected to match so you don't have to choose.)

Sketching

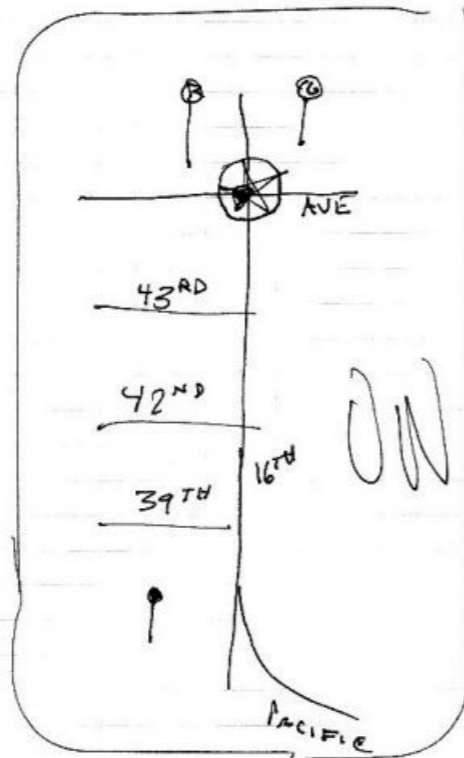

MAP SHOWING PARKING AVAILABILITY BASED ON INPUTTED DATA, INPUTTED ON MAP

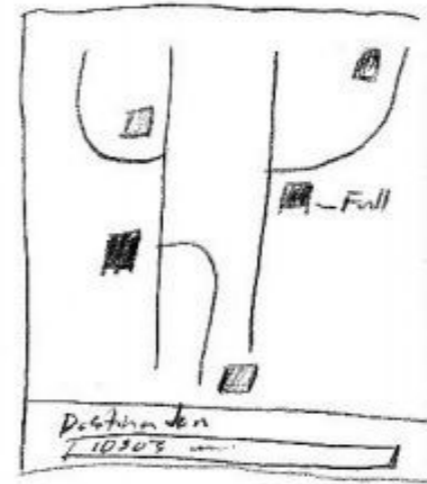

- Different colors
- highlights availability
-

Sketching

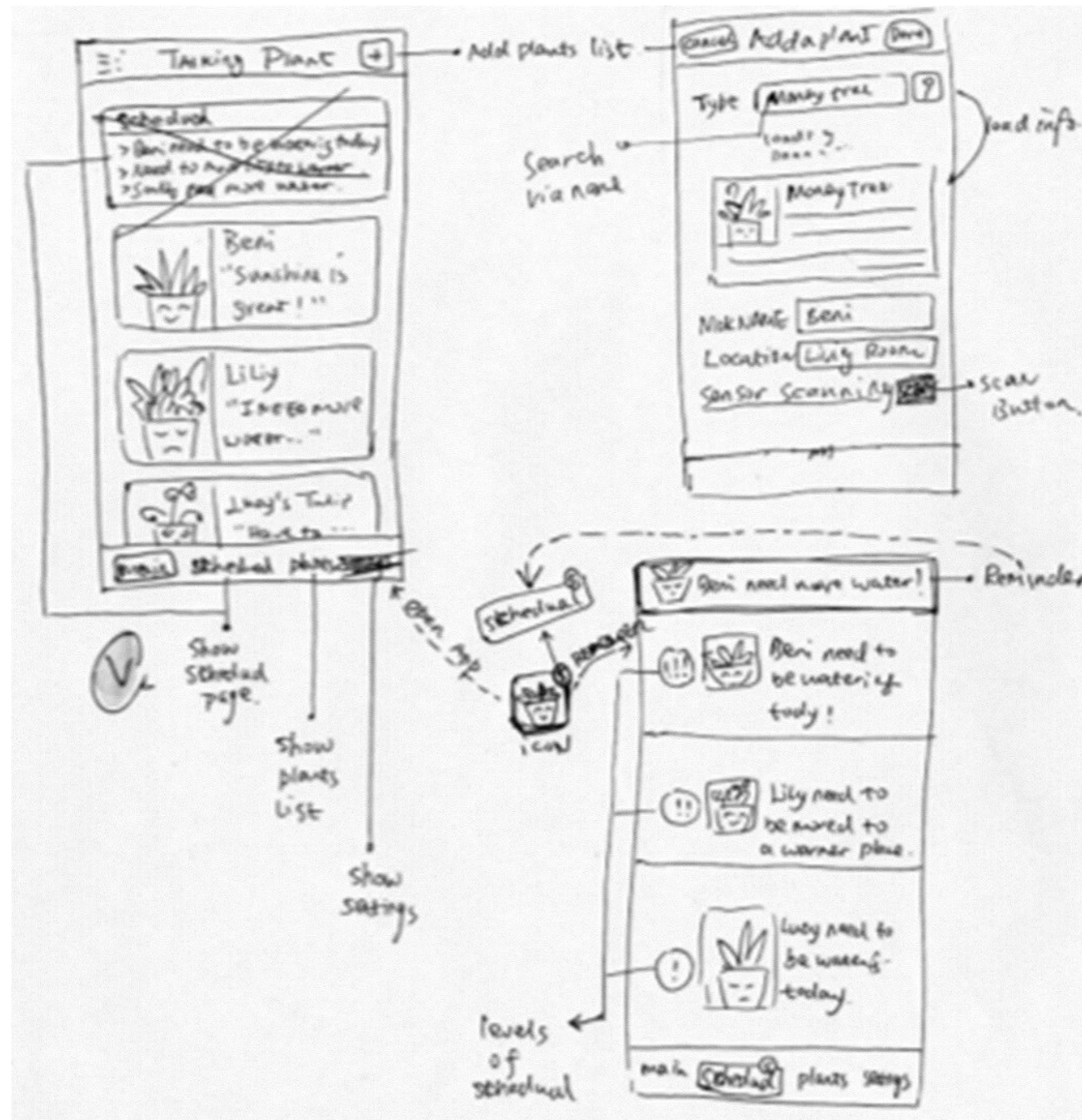

Sketching

A process that enables you to think through ideas and convey design ideas to others very early in the design phase

Sketching = Quintessential Activity of Design

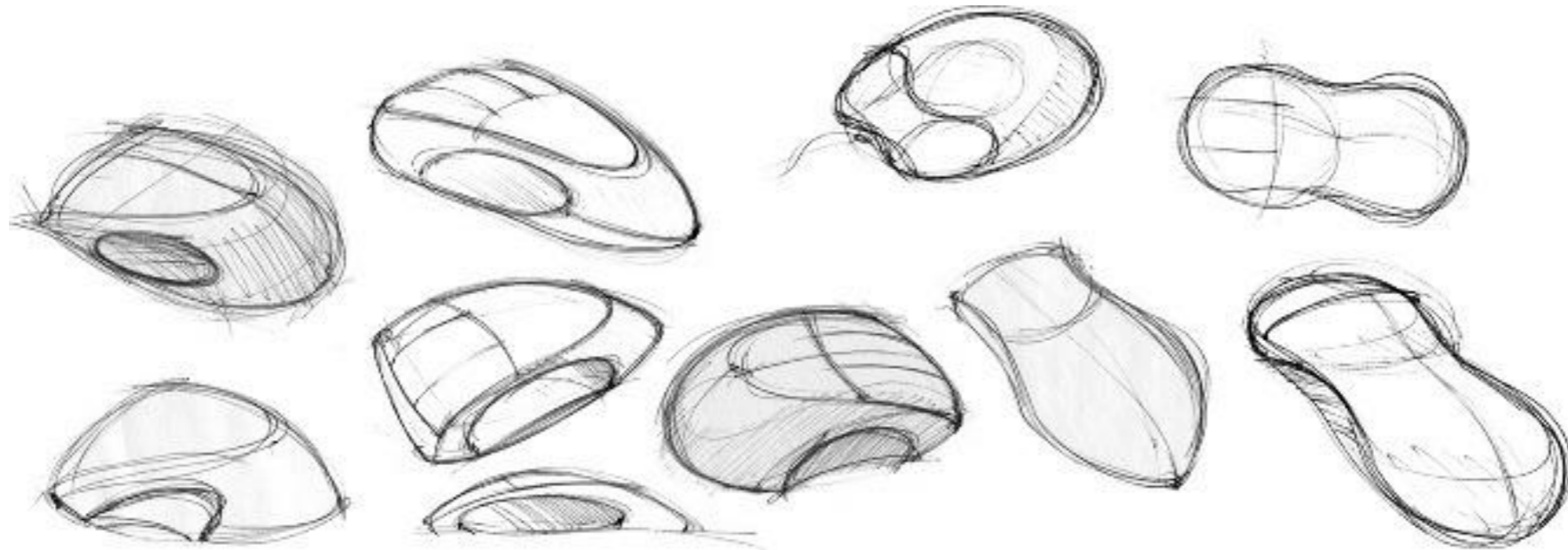

http://payload70.cargocollective.com/1/8/259486/3705937/mouse%20sketch%201.62_2.jpg

Properties of sketches

Quick

Timely

Inexpensive

Disposable

Plentiful

Clear Vocabulary

Distinct Gesture

Minimal Detail

Appropriate

Refinement

Suggest and Explore

Ambiguous

Quick

A sketch is quick to make,
or at least gives that impression

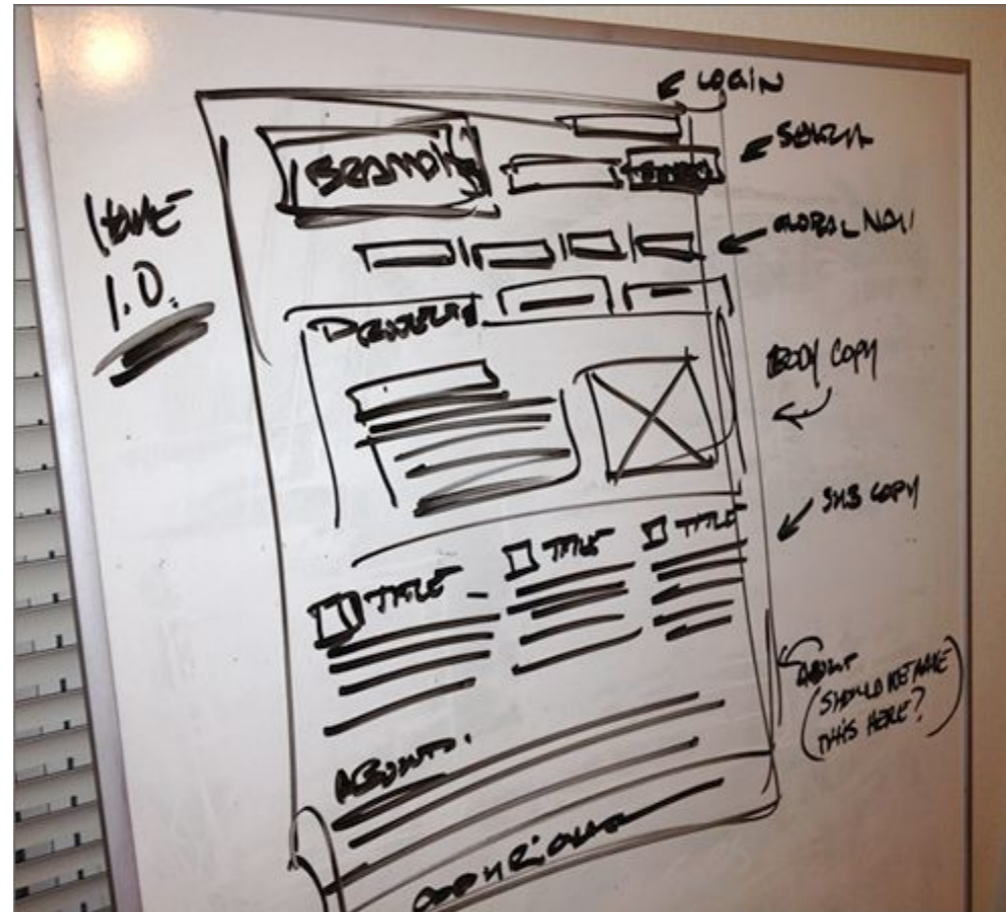

Timely

A sketch can be provided when needed

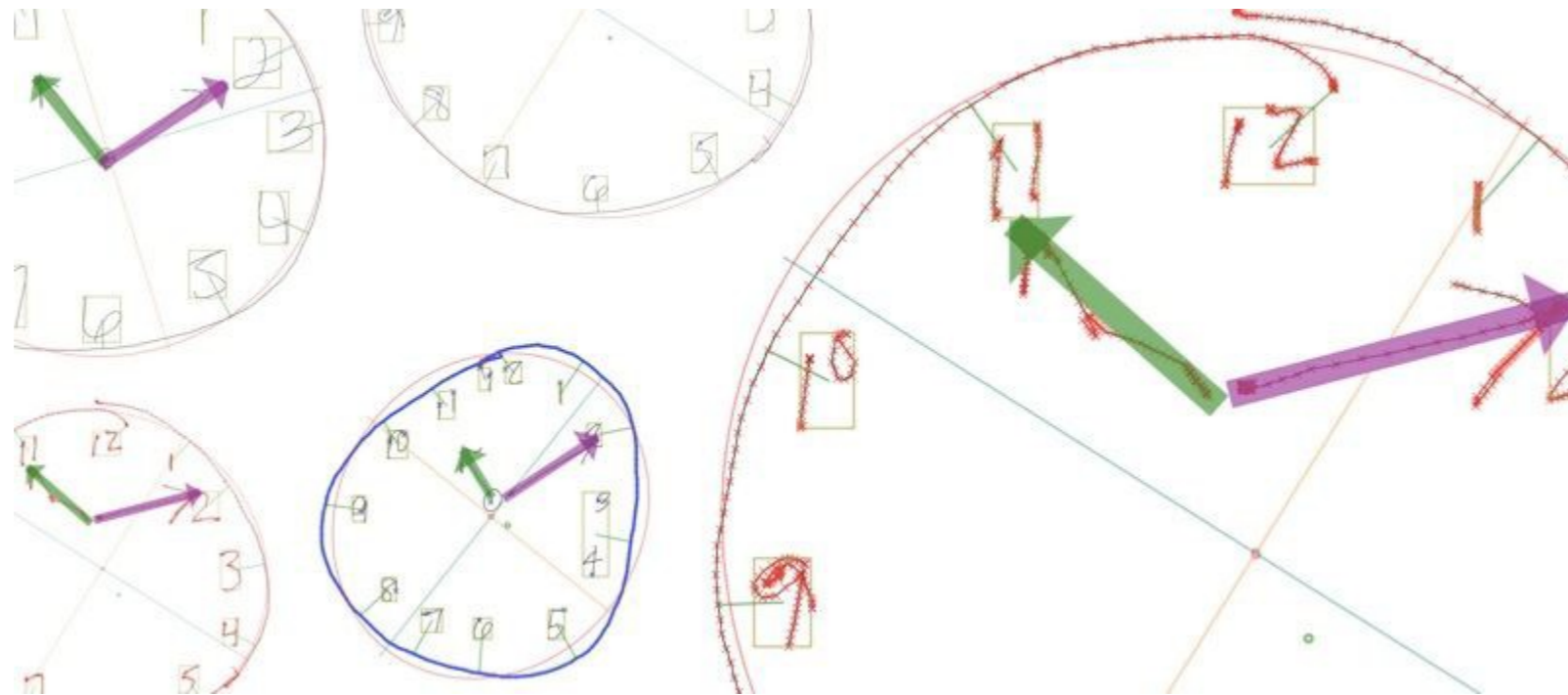

Inexpensive

Cost must not inhibit the ability to explore a concept, especially early in design



Disposable

If you cannot afford to throw it away,
then it is not a sketch

But they are not "worthless"



Plentiful

Sketches do not
exist in isolation

Meaning and relevance
is in the context of a
collection or series



Clear Vocabulary

The way it is rendered makes it distinctive that it is a sketch (e.g., style, form, signals)

Could be how a line extends through endpoints

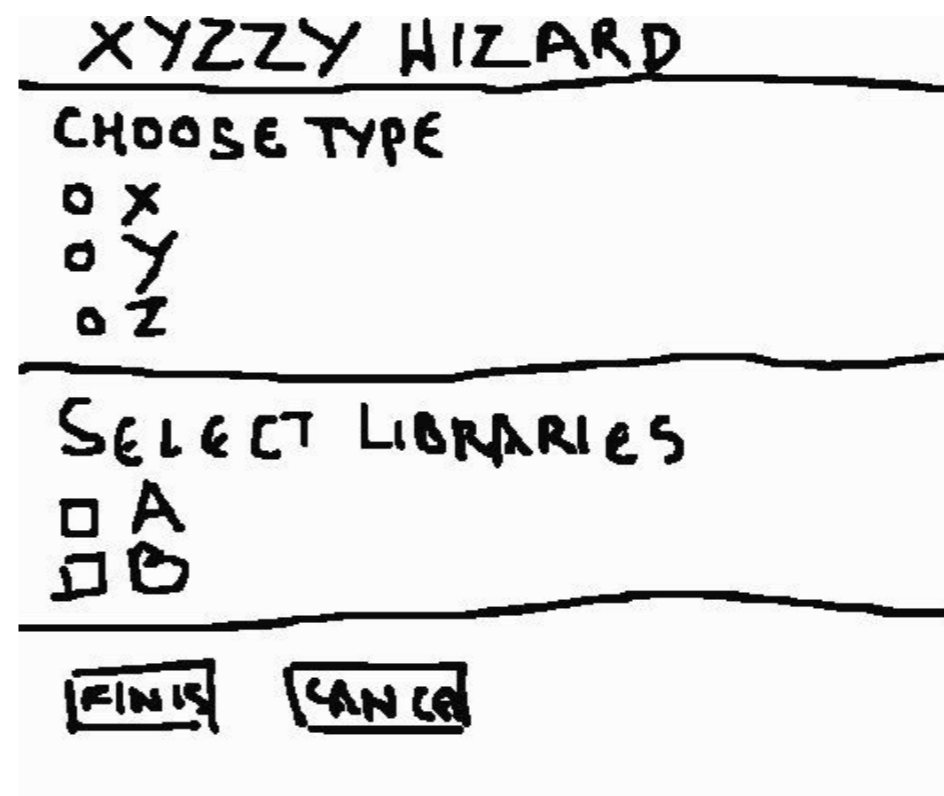

Distinct Gesture

Fluidity of sketches gives them a **sense of openness** and freedom
Opposite of engineering drawing, which is tight and precise

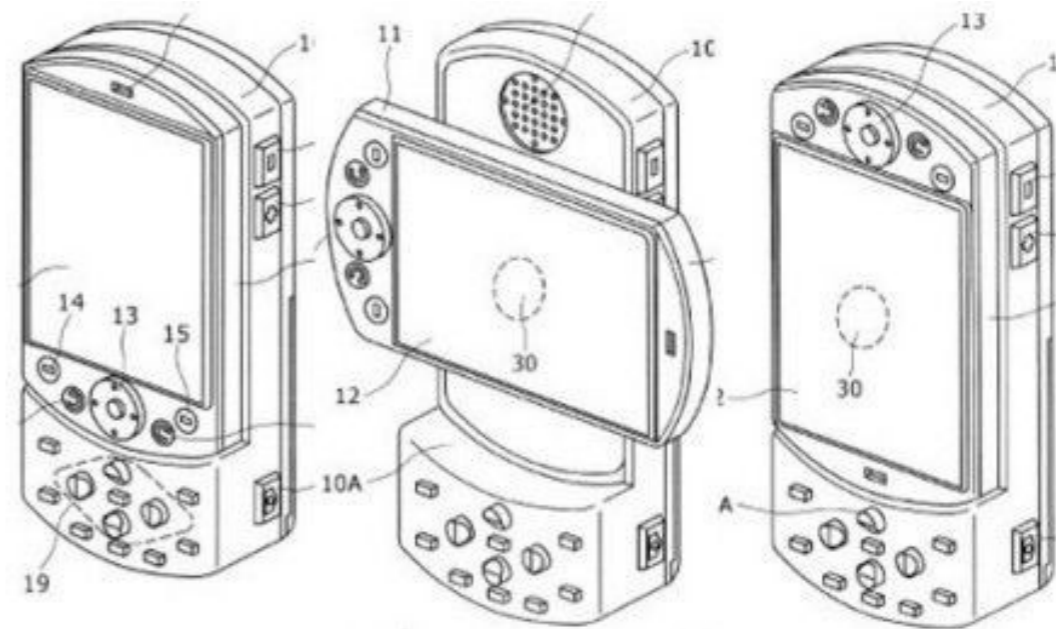
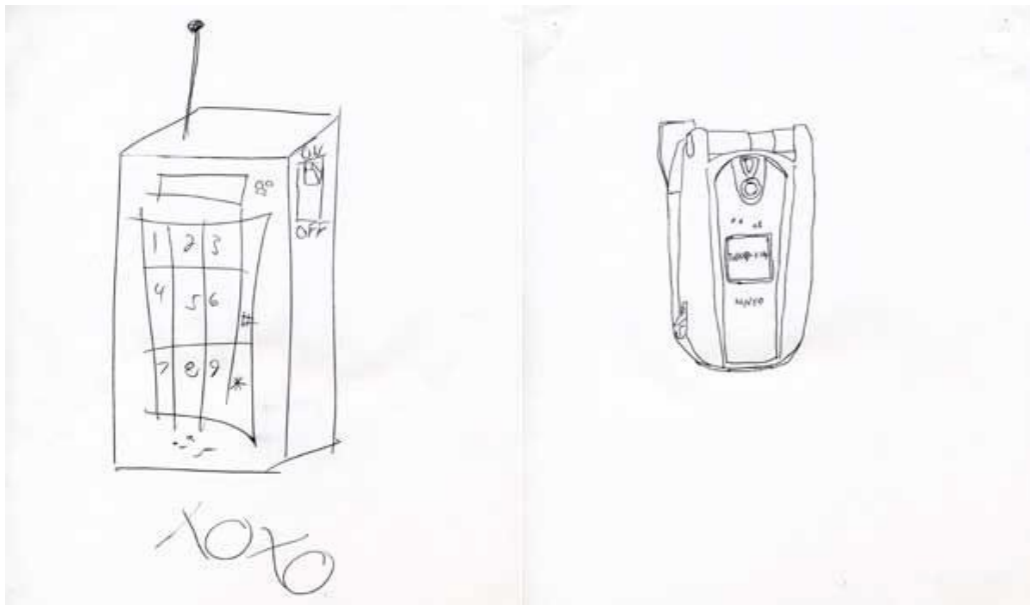

Minimal Detail

Include only what is required to render the intended purpose or concept

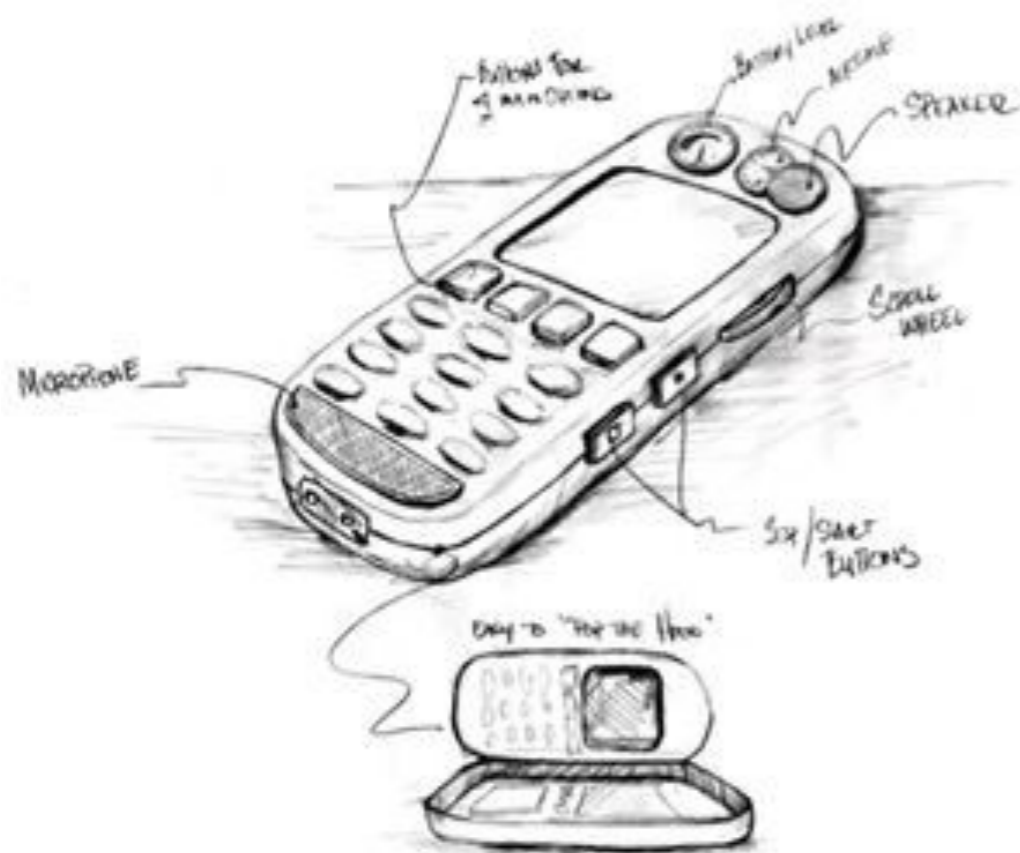

Create JSP for this page

Name:

Number:

Category:

Price Range: to

Minimal Detail

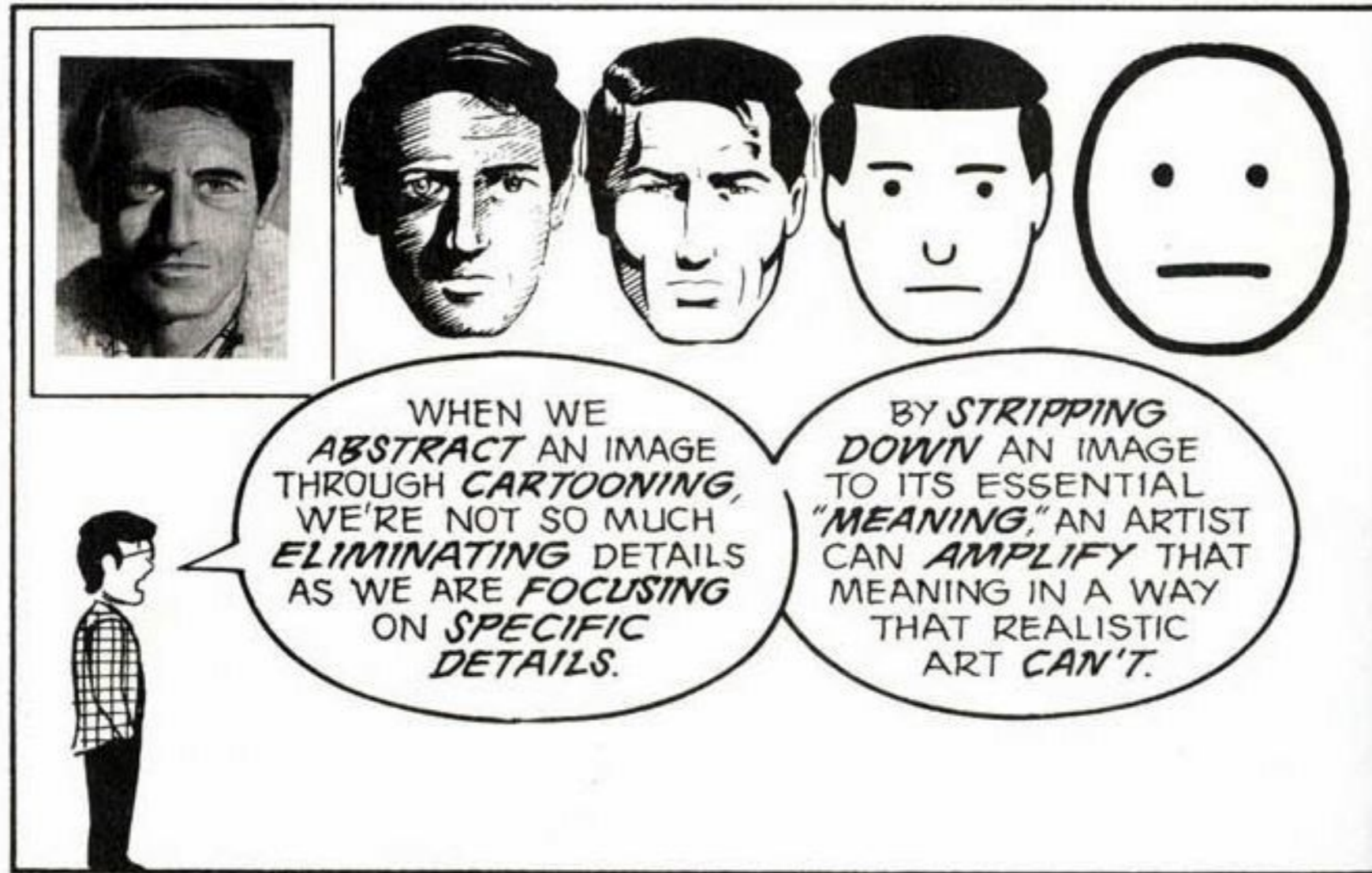

Appropriate Degree of Refinement

Make the sketch as refined as the idea

If you have a solid idea,
make the sketch look
more defined

If you have a hazy idea,
make the sketch look
rougher and less defined

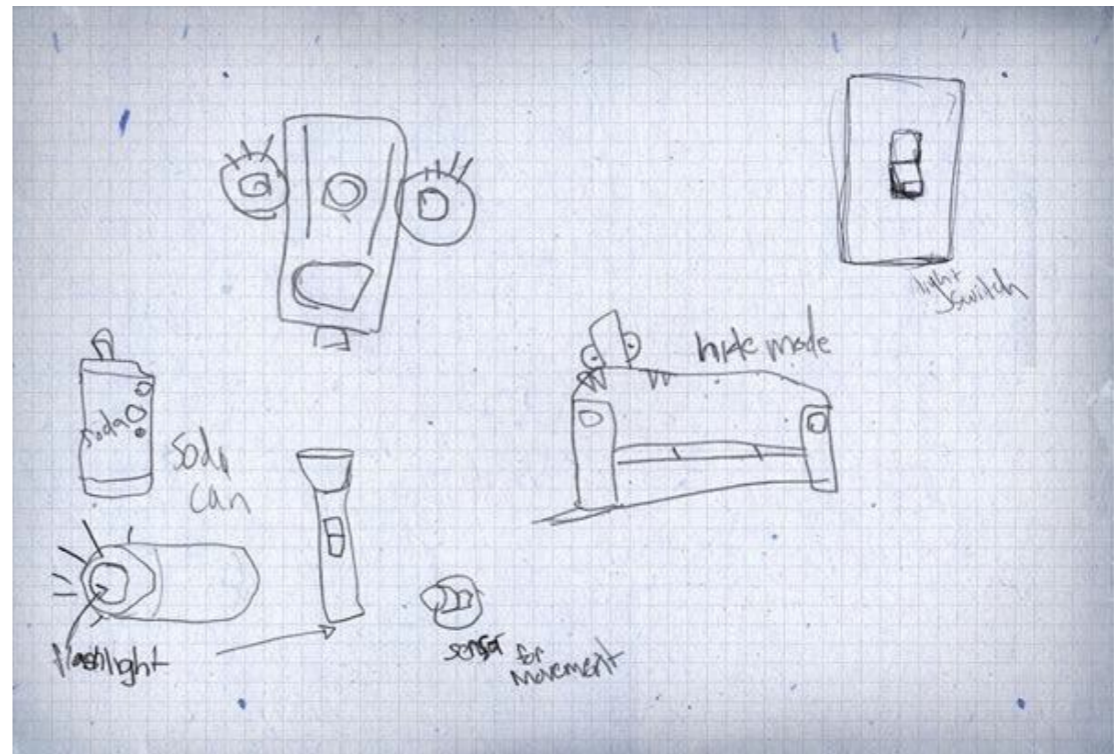

Suggest and Explore Rather than Confirm

Sketch should act as a catalyst to the desired and appropriate behaviors, conversations, and interactions



Ambiguity

Intentionally ambiguous

Value comes from being able to be interpreted in different ways, even by the person who created them

Sketches have holes

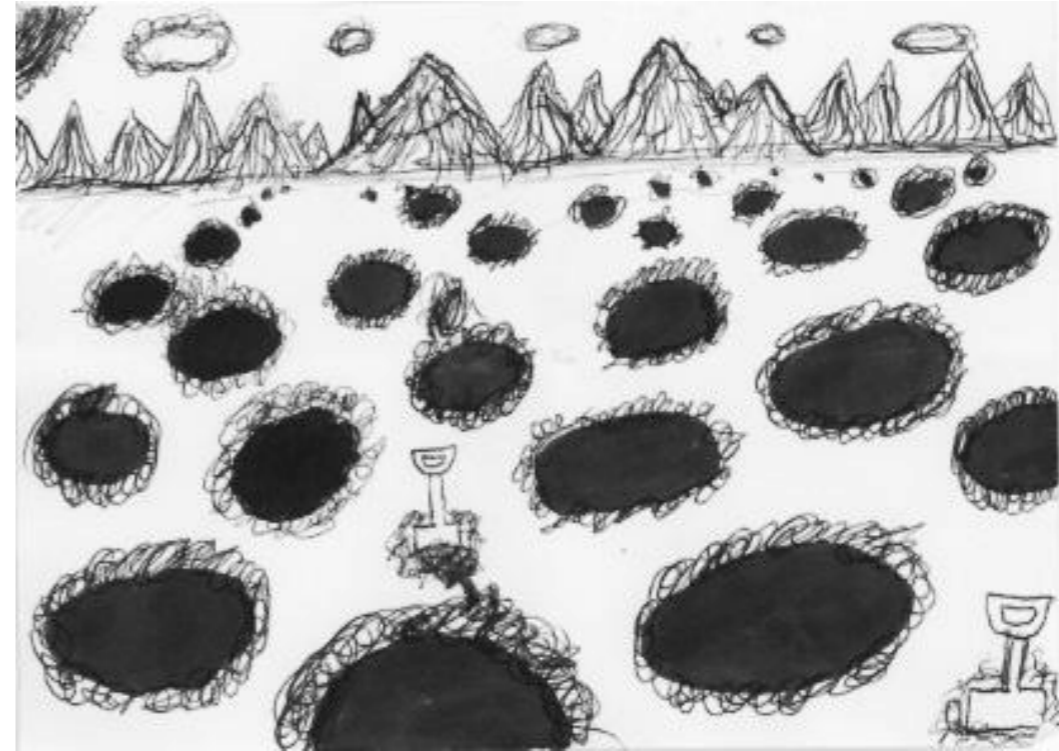

<https://www.deviantart.com/tomalex123/art/Holes-sketch-298354319>

Sketching as Conversation

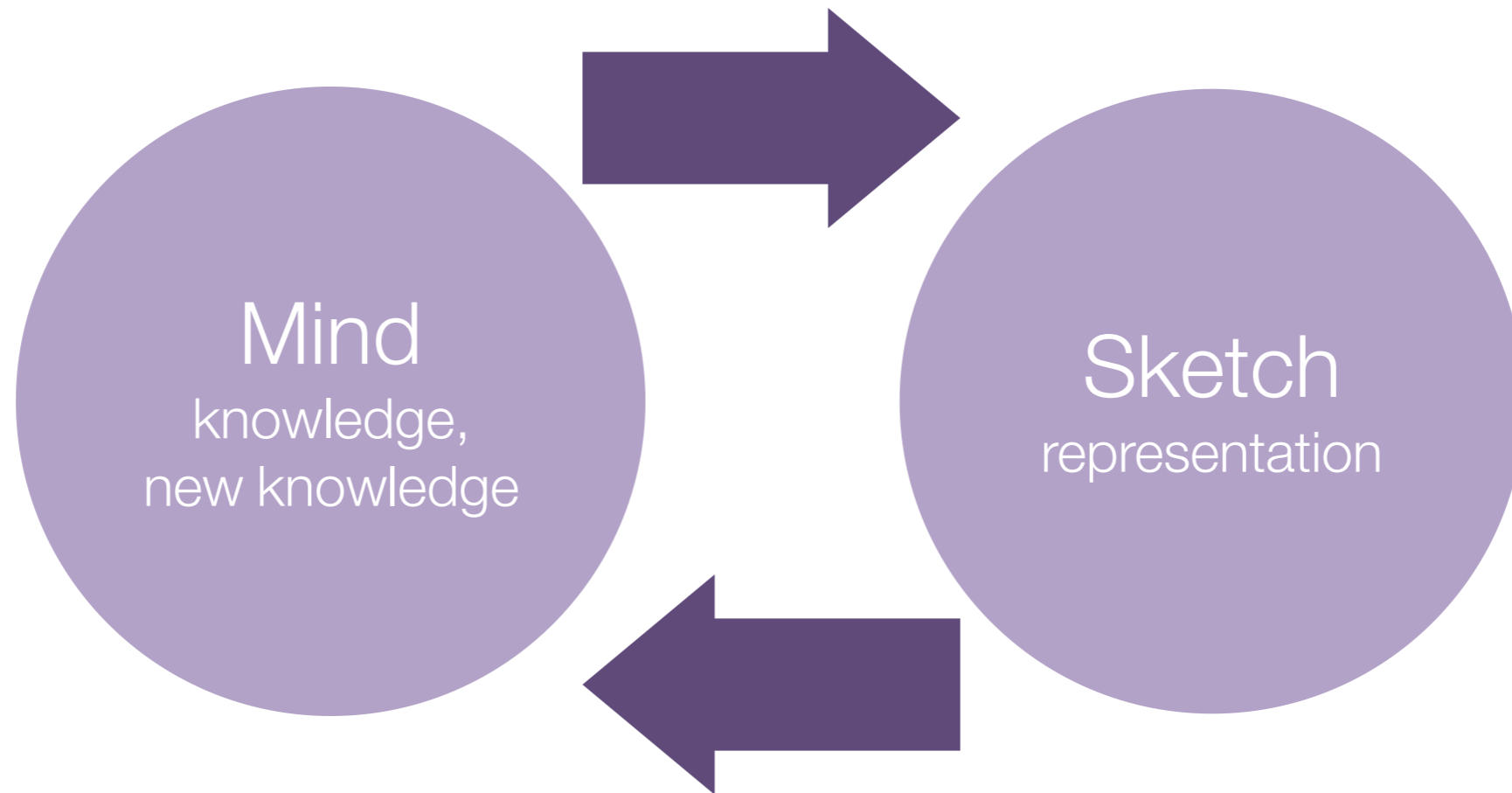

Sketch vs. Prototype

Sketch	Prototype
Invite	Attend
Suggest	Describe
Explore	Refine
Question	Answer
Propose	Test
Provoke	Resolve
Tentative, non committal	Specific Depiction

The primary differences are in the intent

Beyond sketches on paper...



Physical sketching

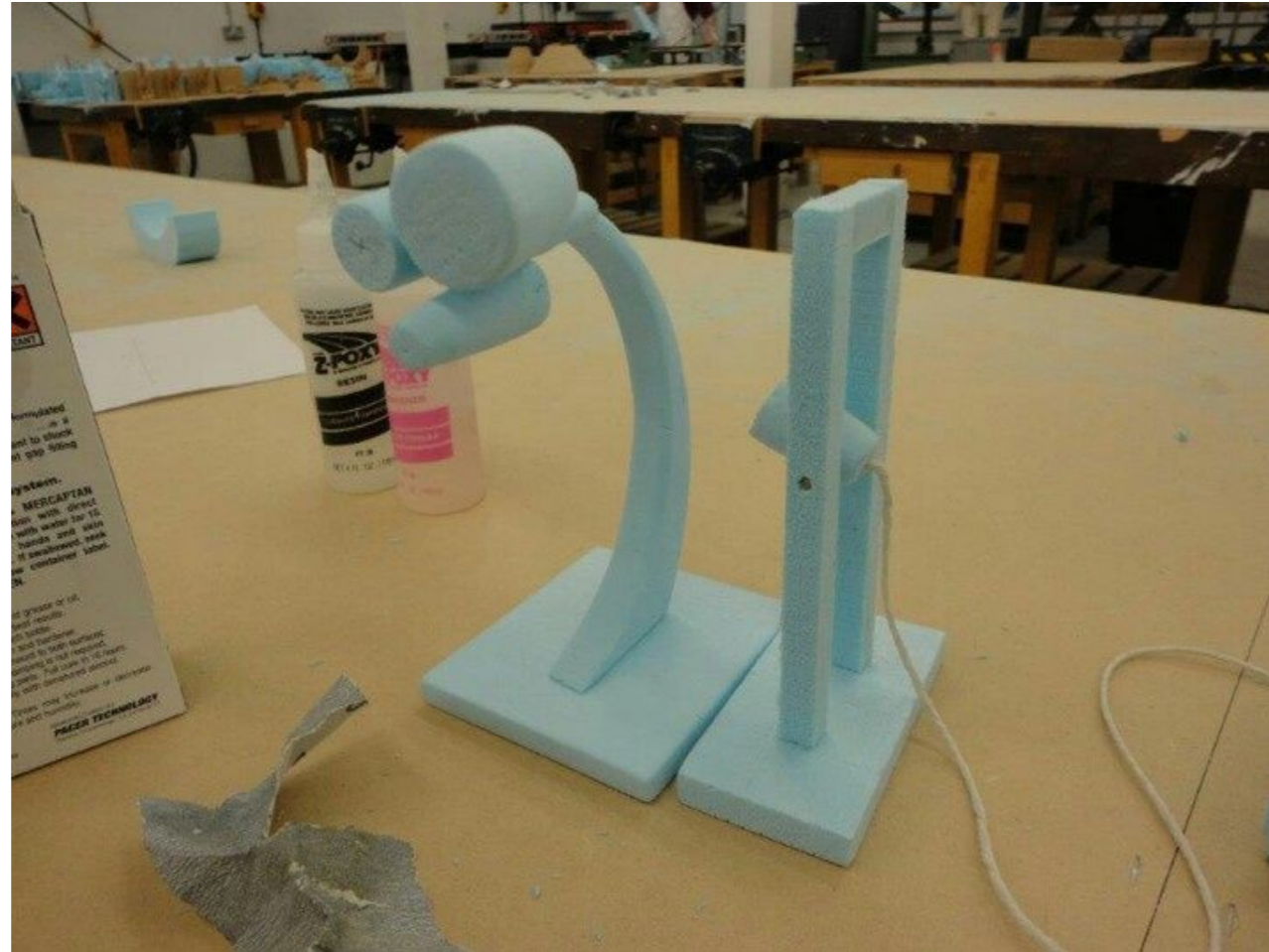

Physical sketching

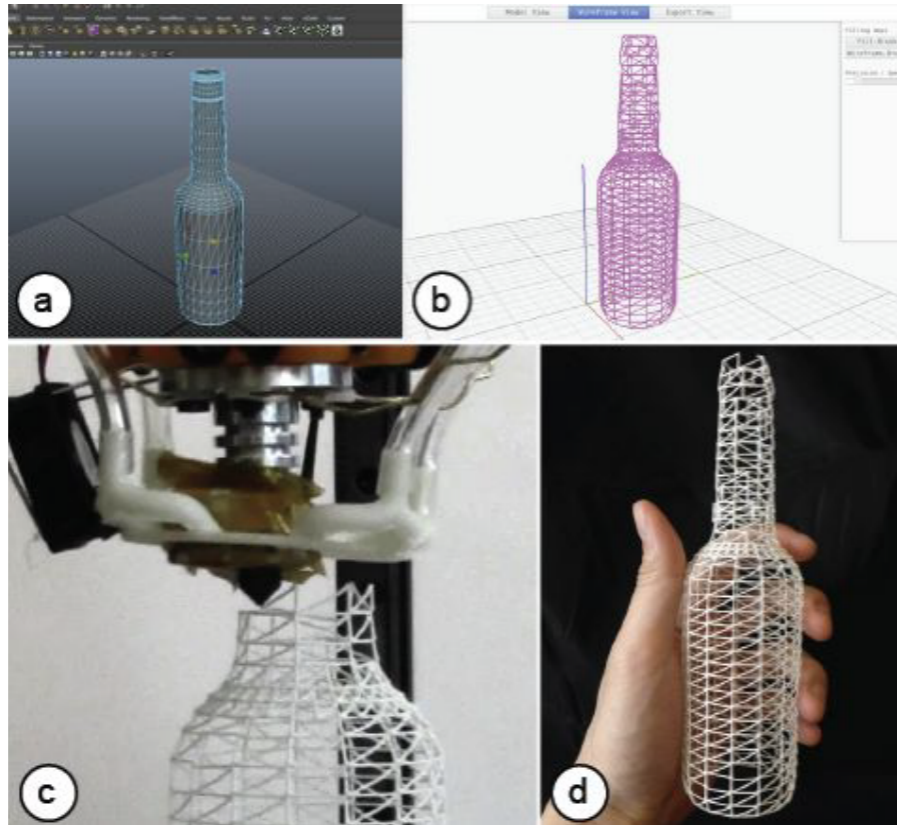

Mueller, WirePrint, UIST2014

Physical Sketching

traditional workflow

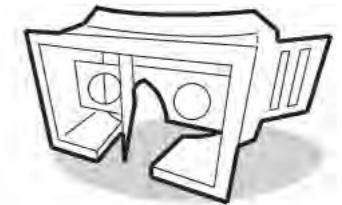
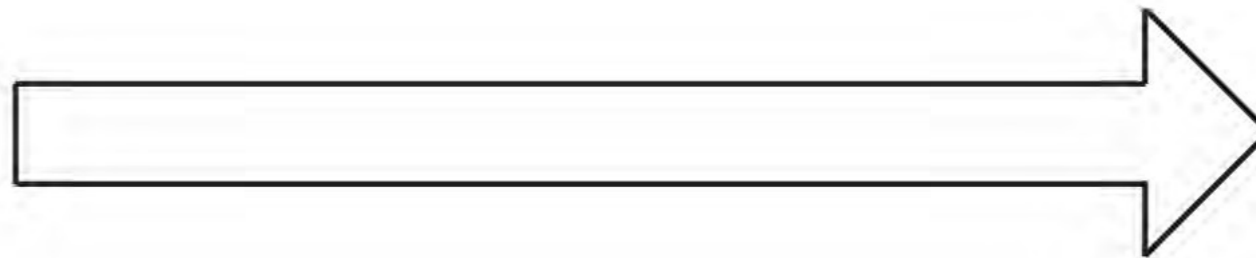
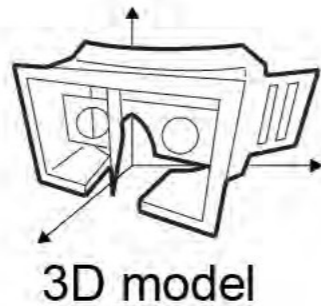

hi-fi fabricated

low-fi fabrication

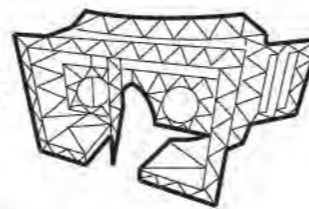
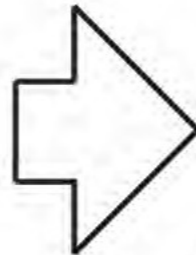
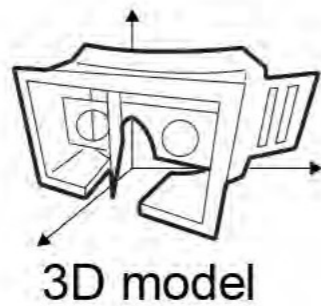

low-fi fabricated

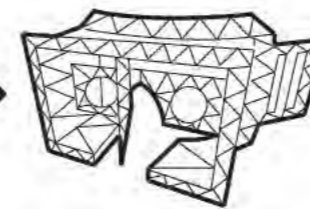
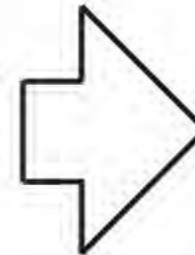

low-fi fabricated

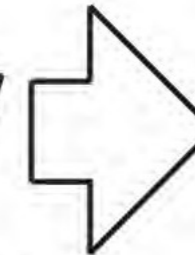

hi-fi fabricated

Lets try it!

Sketching exercise Part 1 (5 minutes)

by yourself, sketch at least 5 new designs for a cup

when you are finished, let's share them



What are the dimensions
of this design space?



Sketching exercise Part 2 (6 minutes)

throw out your old ideas and sketch 10 new cup designs following the different design dimensions



What was your experience?



Design Ideation

People become **fixated** in their design ideas.

Examples can lead to reinterpretation and recombination of ideas.

Defining the solution space increases people's creativity.



Creativity

More Evidence

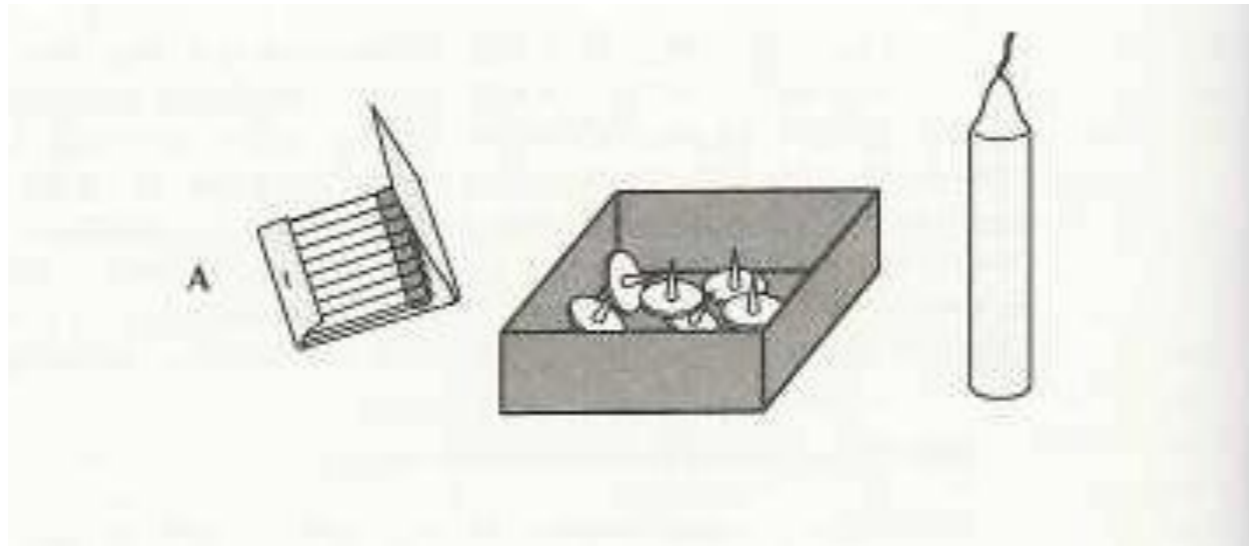

[The Candle Problem](#)

More Evidence

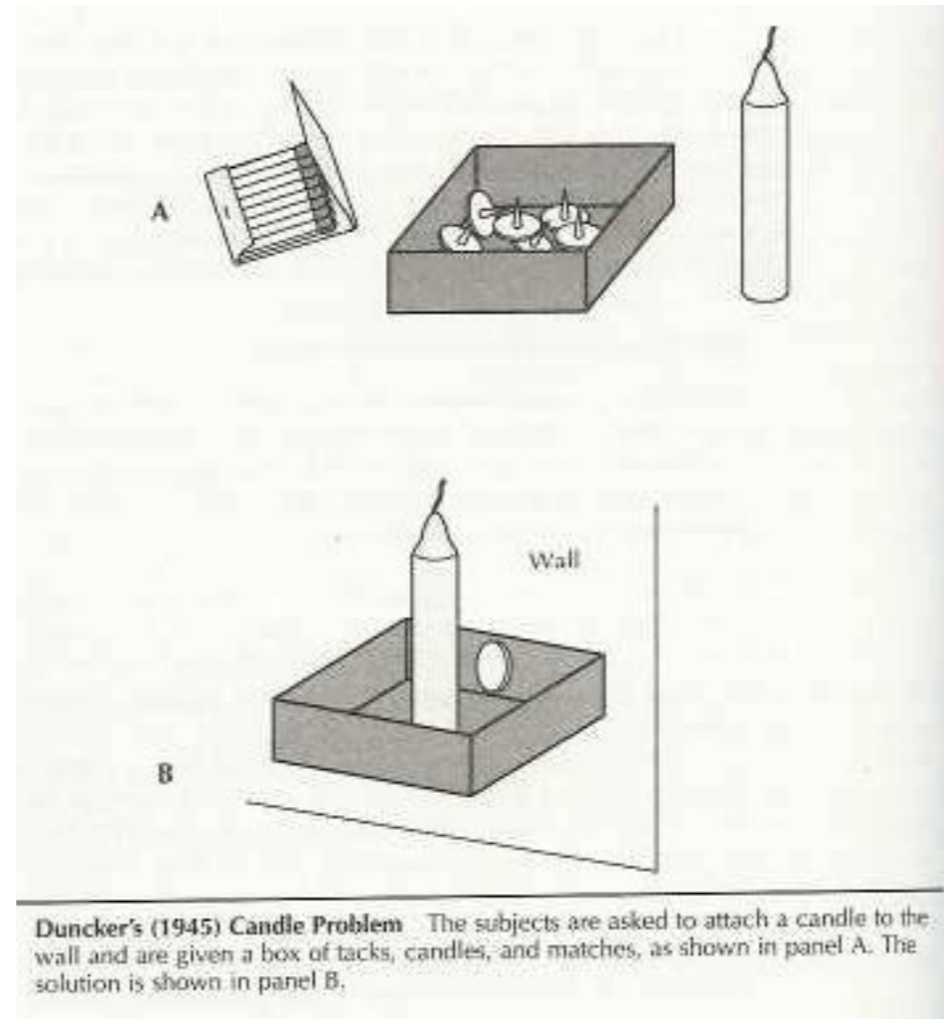

Quantity versus Quality

Pottery study:

One class was told they will be graded on quality, another one on quantity



Quantity versus Quality



The quantity class produces better pots. Why?

Quantity versus Quality

The quantity class produces better pots. Why?

“While the quantity group was busily churning out piles of work—and learning from their mistakes—the quality group had sat theorizing about perfection, and in the end had little more to show for their efforts than grandiose theories and a pile of dead clay”

More Evidence

Task:

Create a web banner ad for Ambidextrous magazine.



More Evidence

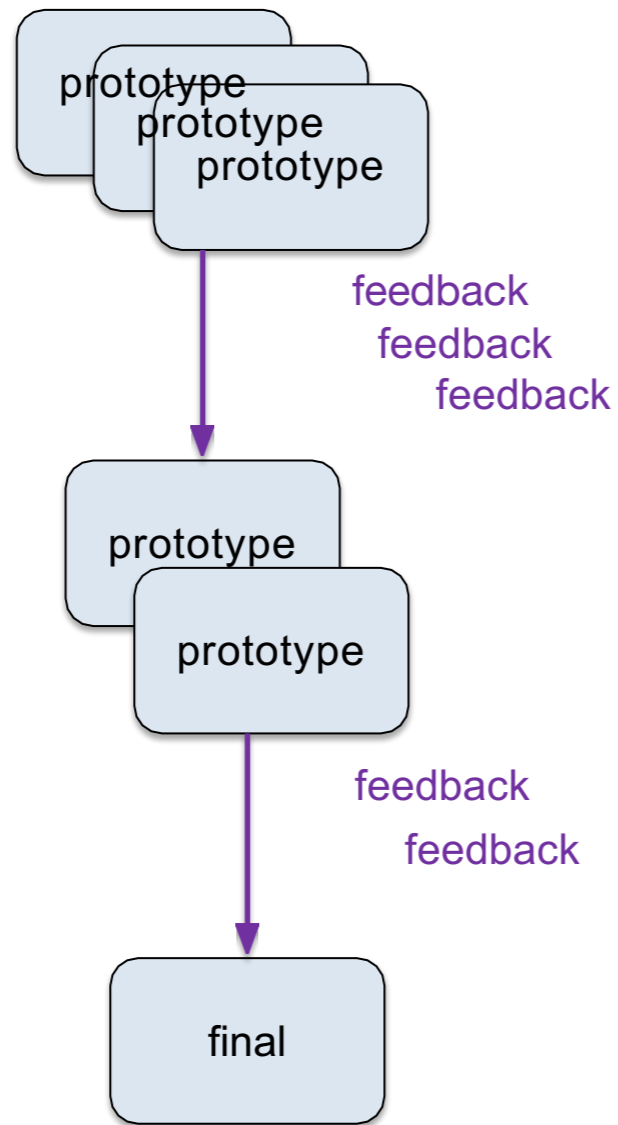

Parallel condition

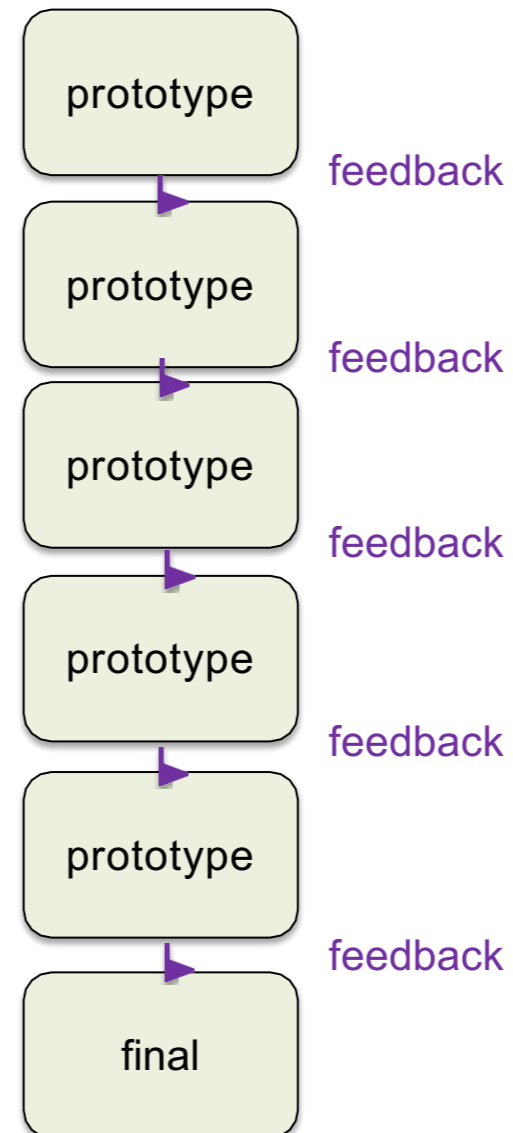

Serial condition

More Evidence

serial
prototyping
condition



parallel
prototyping
condition

The parallel prototyping condition also led to significantly higher click-through rates.

Parallel: more diverse, better, more clicks

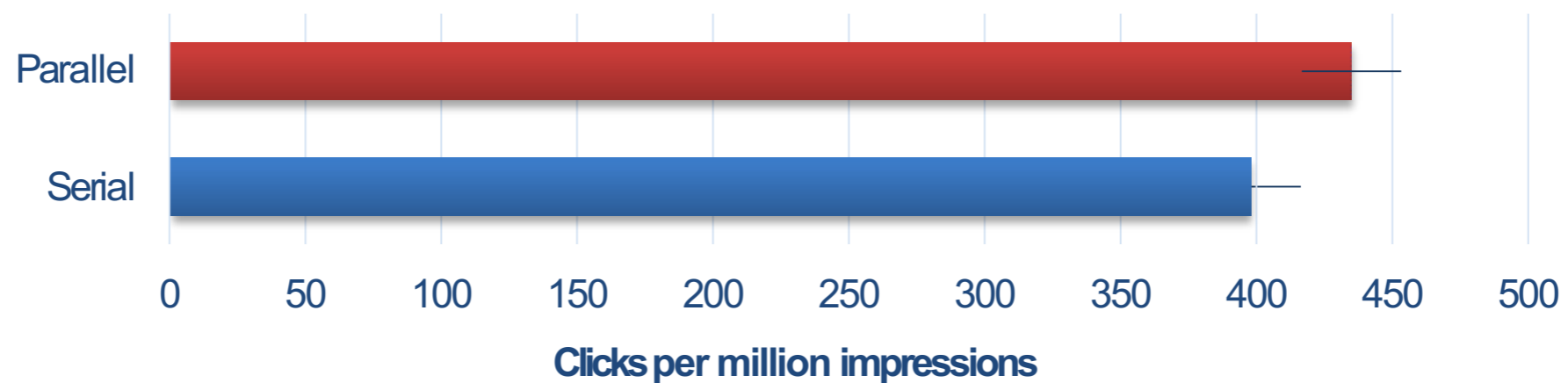
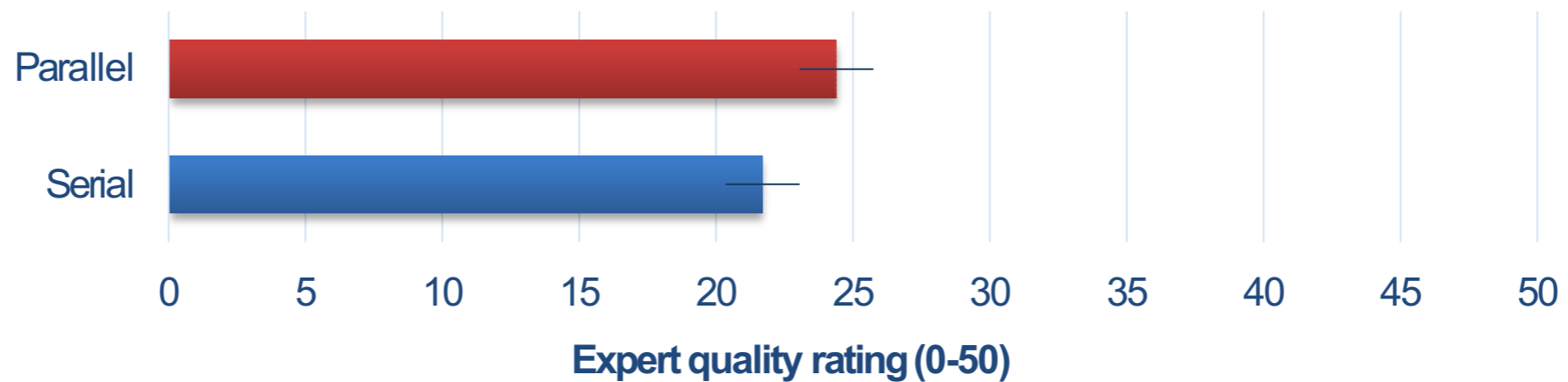
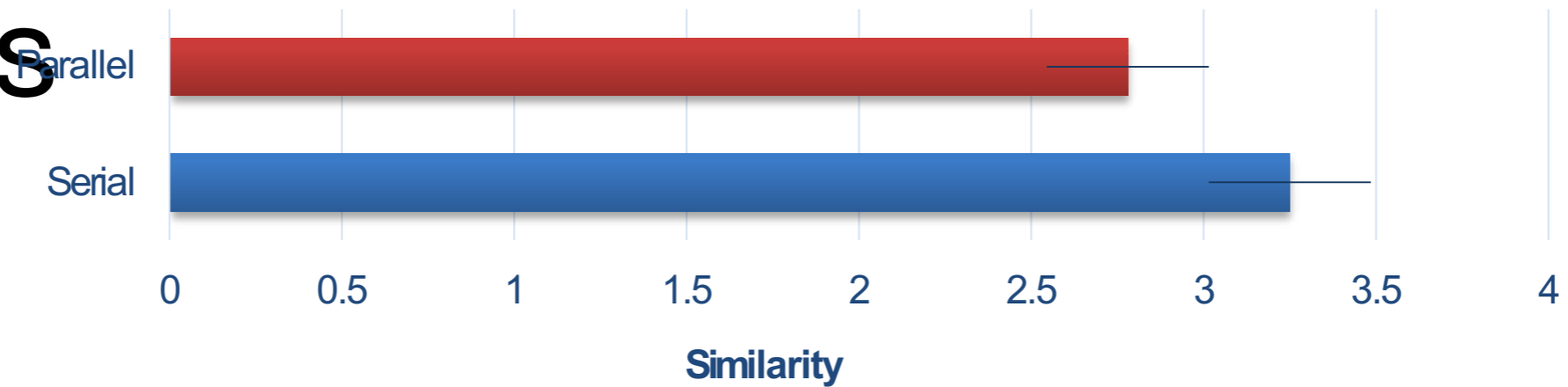

Summary

Greater divergence in designs

- Prevents sticking with the first idea

- Allows mashing ideas together

Alternatives facilitate feedback

- Enable comparison

- Can improve tone of critique

So how do people do this in practice?

IDEO Shopping Card Project (start 4:55)



Is this a sketch? Why or why not?

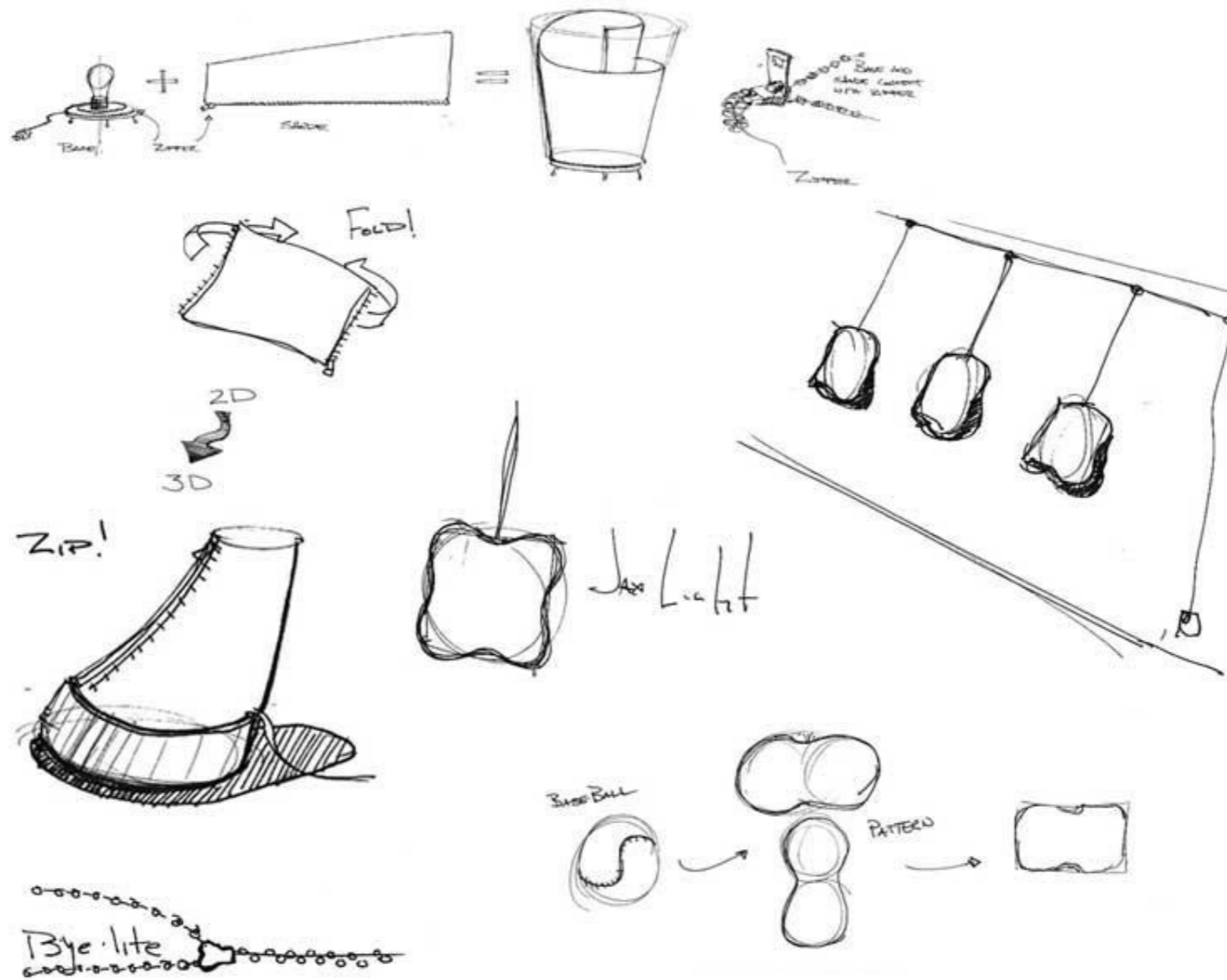

Is this a sketch? Why or why not?

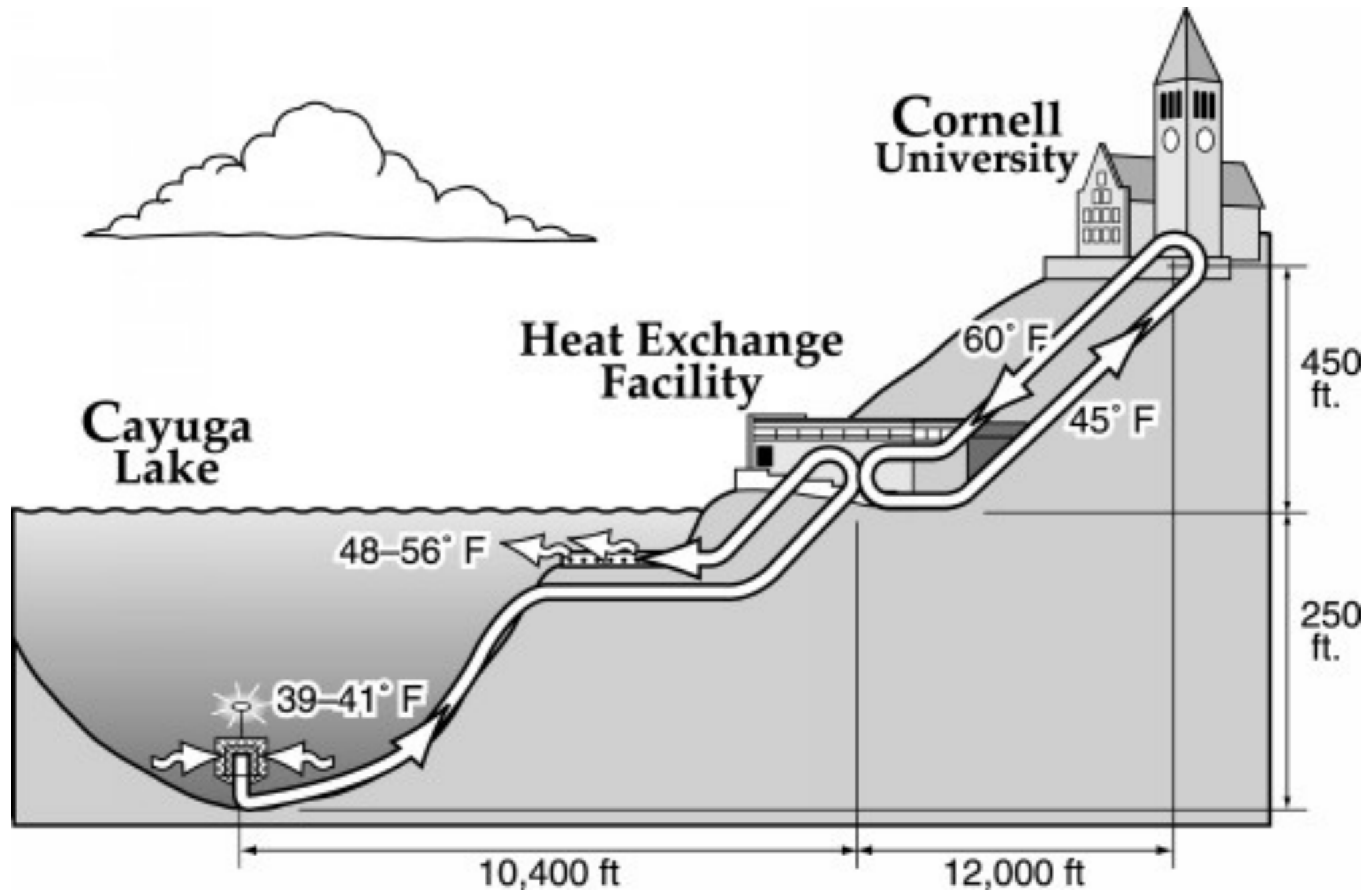

Is this a sketch? Why or why not?

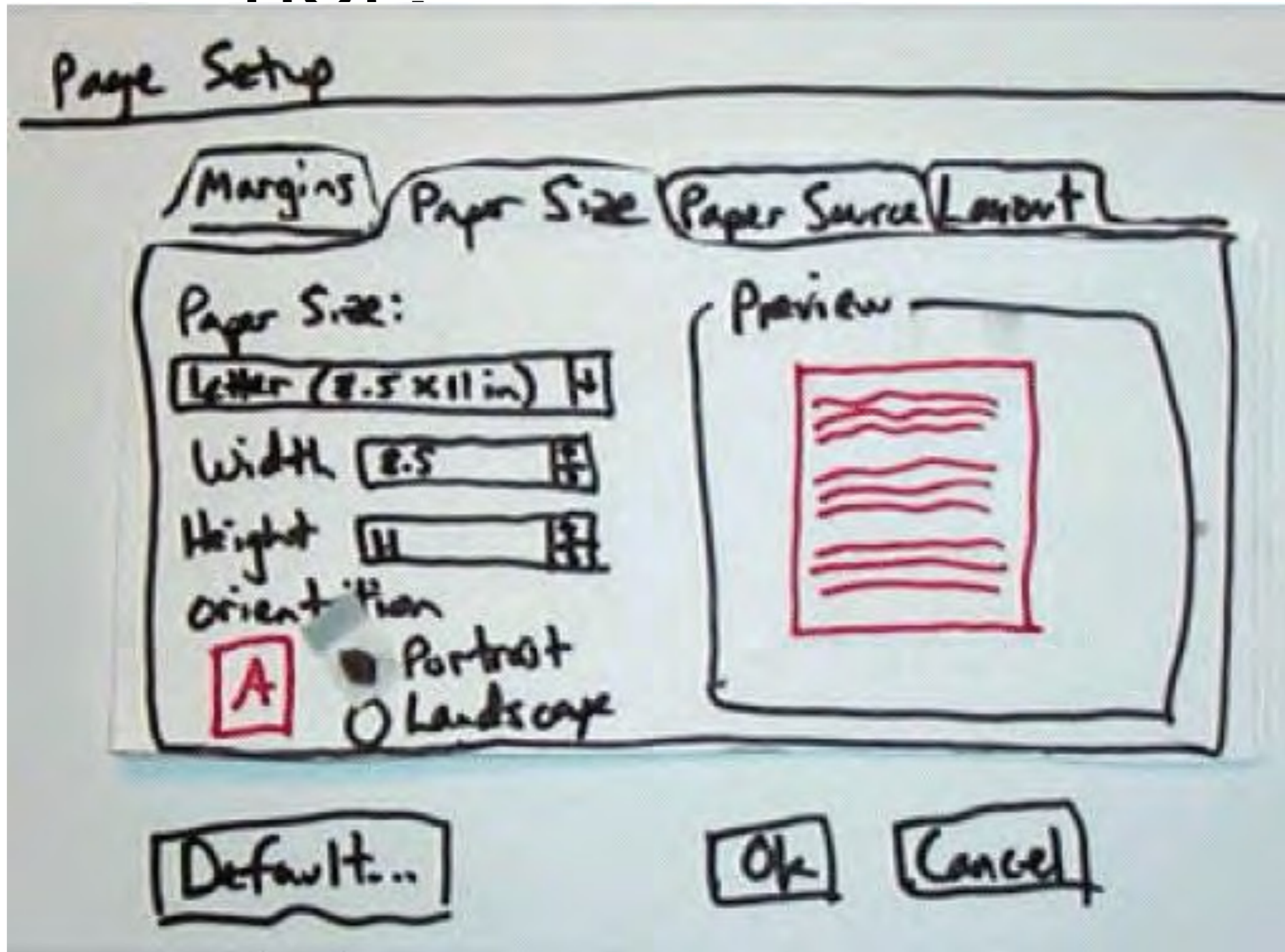

Is this a sketch? Why or why not?



Is this a sketch? Why or why not?



Is this a sketch? Why or why not?



Is this a sketch? Why or why not?

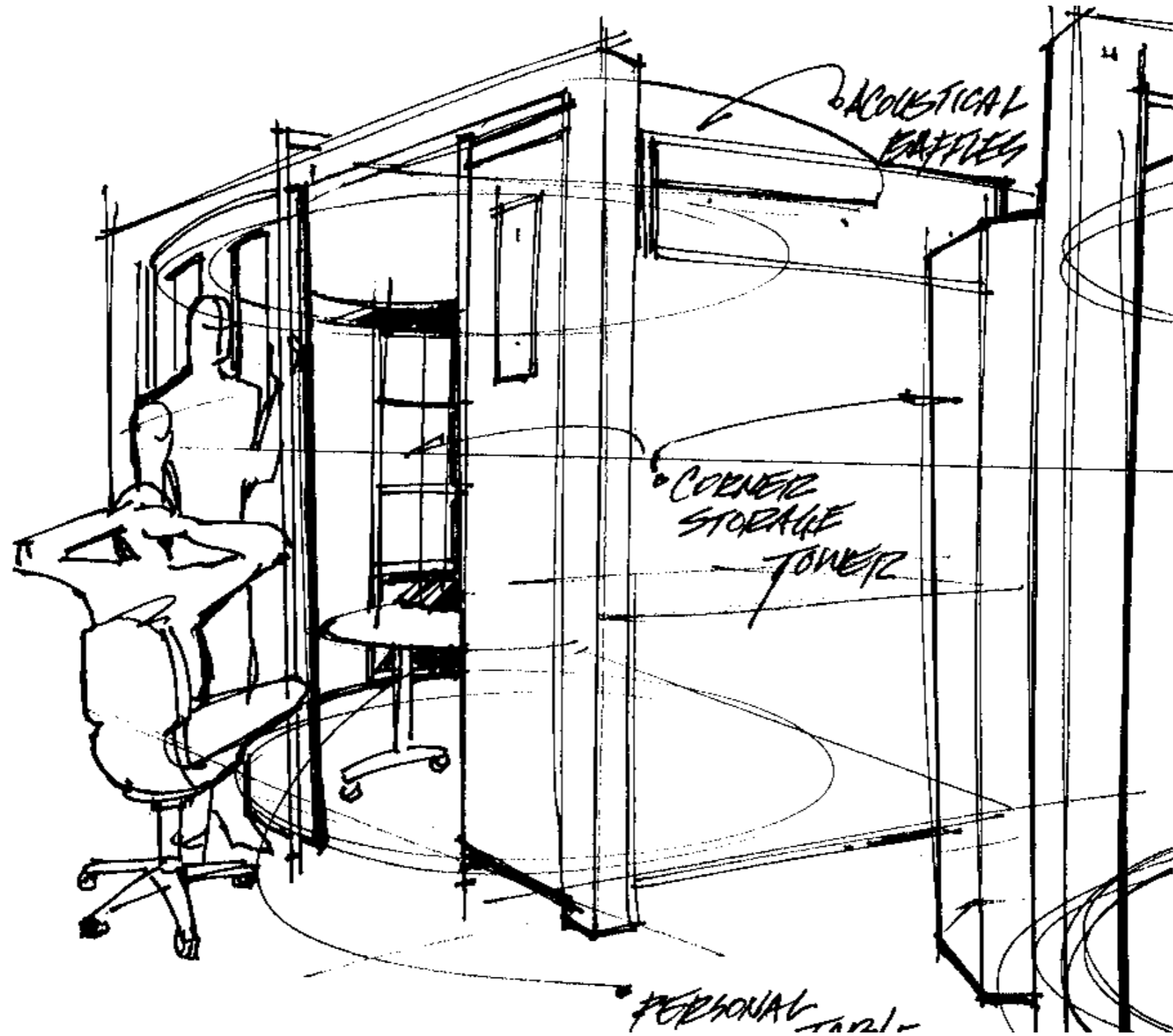

Is this a sketch? Why or why not?



Questions